

HS-70MG General Specification.

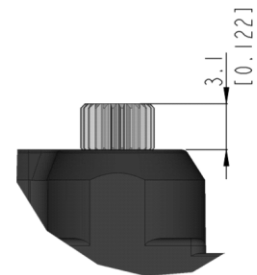

Control System	PWM			-
Position Sensor Type	Contact Analog Potentiometer			-
Motor Type	Cored Metal Brush			At 25°C(±10%), 45%RH(±10%) <u>measurement environment</u>
Operating Voltage Range	4.8 ~ 6.0V			
Voltage	4.8V	6.0V	-	
No Load Speed	0.17sec/60°	0.14sec/60°	-	
Stall Torque	2.4kgf-cm (33.33oz-in)	3.0kgf-cm (41.66oz-in)	-	
Peak Efficiency Torque	0.5kgf-cm (6.9 oz-in)	0.6kgf-cm (8.3 oz-in)	-	
Standing Current	8mA	8mA	-	
No Load Running Current	140mA	160mA	-	
Stall Current	960mA	1,000mA	-	
Deadband	4μs	4μs	-	
Operating Travel	Default: ±60°, Non-programmable / Pulse Width: 900~2100μs(Center:1500μs)			-
Continuous Rotation	n/a			-
Operating Temperature Range	-20°C ~ +60°C (-4°F ~+140°F)			-
Storage Temperature Range	-30°C ~ +80°C (-22°F ~+176°F)			-
Connector Wire Length	160mm (6.299inch)			
Connector Wire Gauge	28AWG			
Dimensions	23.6mm x 11.6mm x 30.0mm (0.929inch x 0.457inch x 1.181inch)			General Tolerance ±0.1mm
Weight	12.5g (0.441oz)			Excluding the weight of Horn
Bearing Type	1 Ball Bearing			-
Case Material	Engineering Plastic			-
Gear Material	1 Resin & 4 Metal Gears			-
Gear Train Backlash	Max 0.5°			-
Horn Gear Spline	M25T(Ø5)			-
IP-Rating	IP4X			-
Servo Amplifier Type	Analog Contorller			-

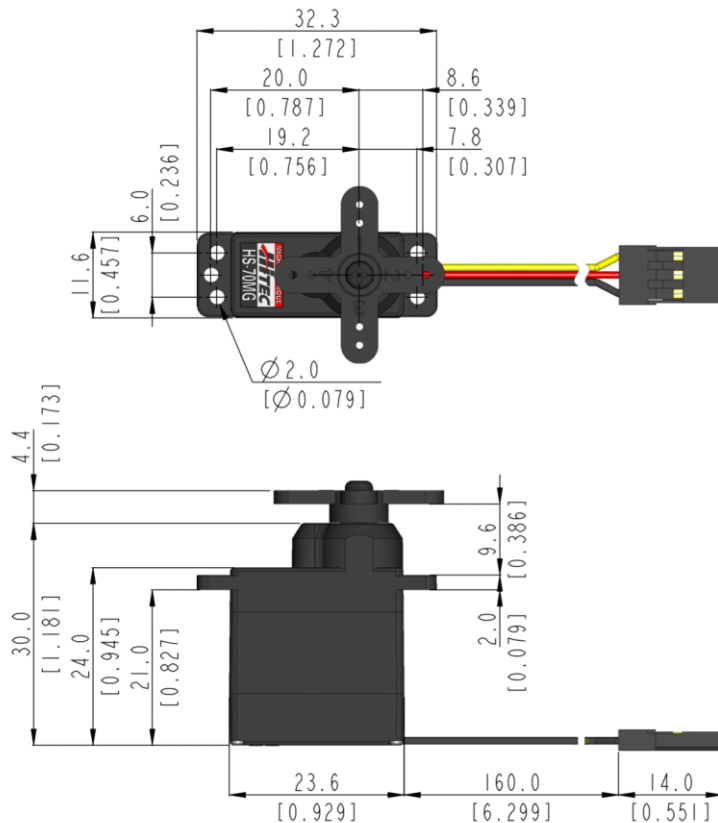

1:1 scale (Unit : mm[inch])

- This product should not be used directly on the human body for medical purposes.
- All specifications are subject to change without notice.



9001:2015
14001:2015
CERTIFIED



HitecCS.com